

3 1/2" INSWING FRENCH DOOR COMBINATION MULLS

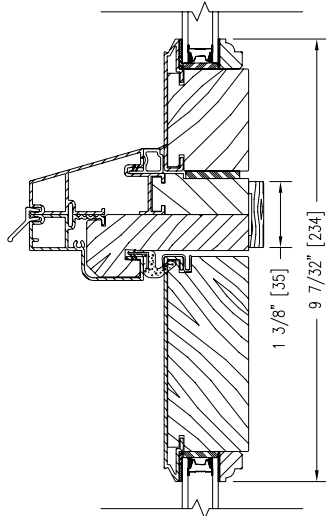

INSWING TRANSOM OVER
INSWING DOOR

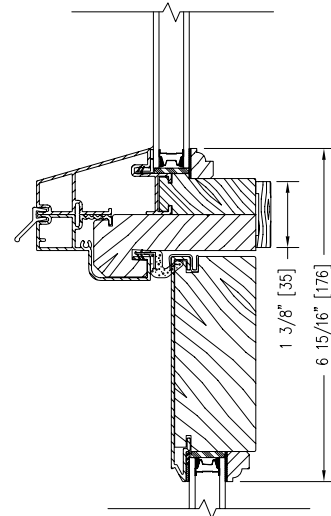

DIRECT GLAZED TRANSOM OVER
INSWING DOOR

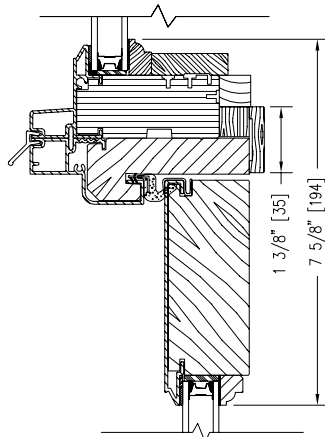

AUXILIARY OVER
INSWING DOOR

Notes:

Dynamically configure section details to your specific needs by going to EagleWindow.com, select Wintelligence. Eagle Window & Door reserves the right to change the specifications without notice.

DRAWING # AD3121
SCALE: 3"-1'-0"
REVISION: 2/2/09

