

3 1/2" INSWING FRENCH DOOR HORIZONTAL FACTORY MULLS

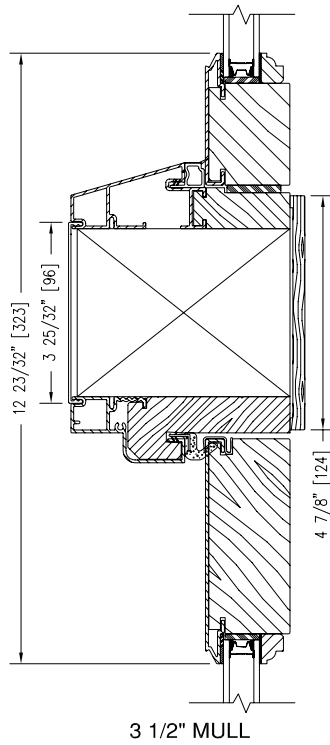
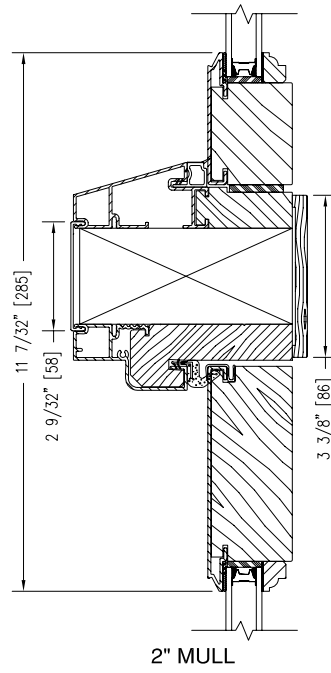
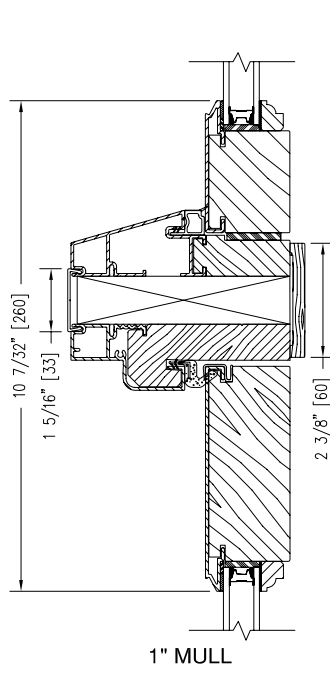

Notes:

Dynamically configure section details to your specific needs by going to EagleWindow.com, select Wintelligence. Eagle Window & Door reserves the right to change the specifications without notice.

DRAWING # AD3120
SCALE: 3"-1'-0"
REVISION: 2/2/09

